



Valves and automation for hygienic use

The complete line





Valve matrix –

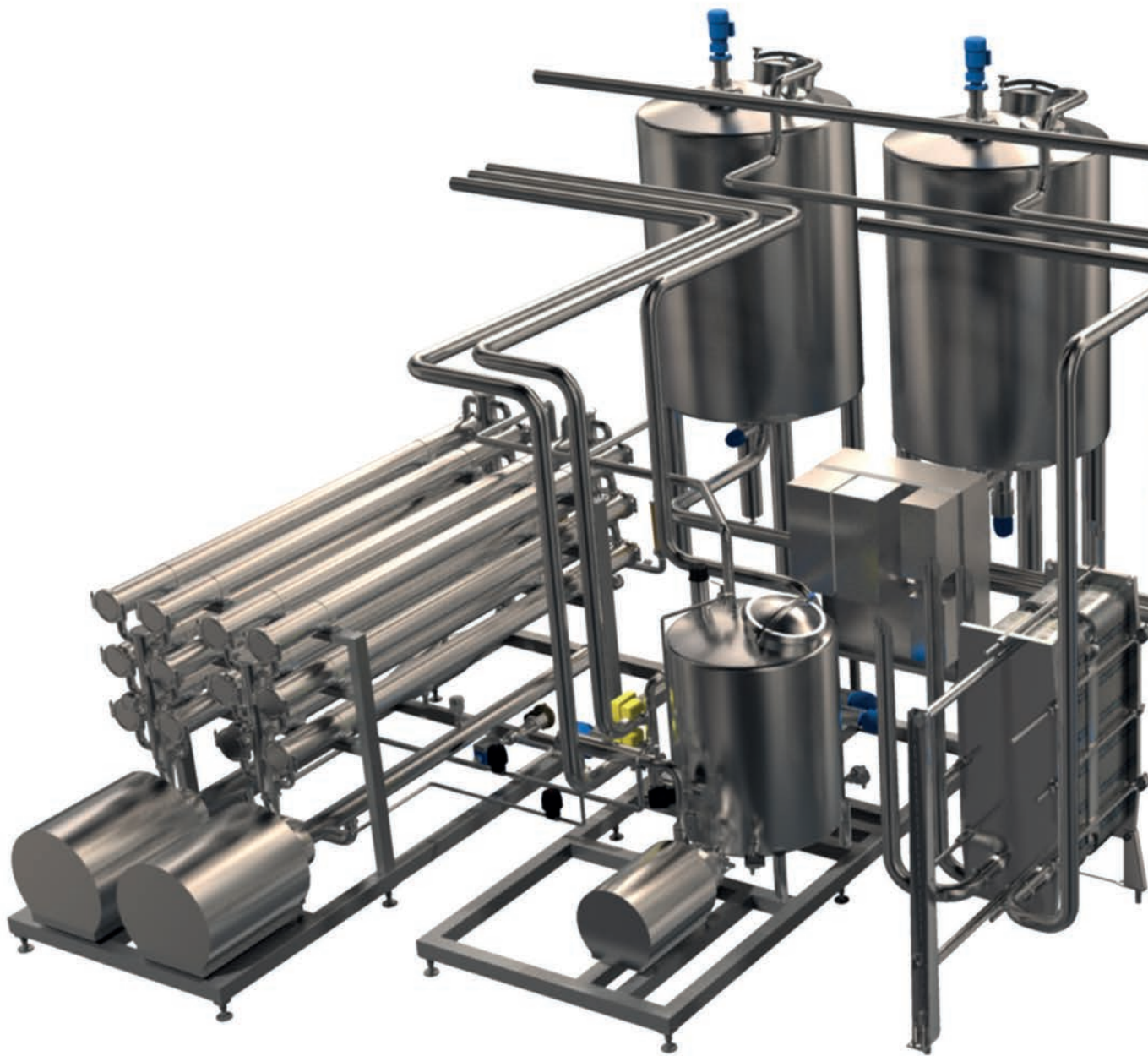

customized flow solutions

Alfa Laval valve matrix solutions

We are specialists in providing pre-built valve matrices customized to meet individual requirements.

Our expertise helps ensure you the most efficient flow management, using as few components as possible and dealing effectively with key issues that include thermal cycling, cleanability, drainability and flow control.

Alfa Laval valve matrix solutions can be supplied pre-assembled and pre-tested as well as fully wired and with all the necessary pneumatic tubing, junction boxes and control panels pre-connected.

This means you can bring even complex installations online as quickly as possible, saving time and avoiding lost revenue associated with onsite troubleshooting and downtime.

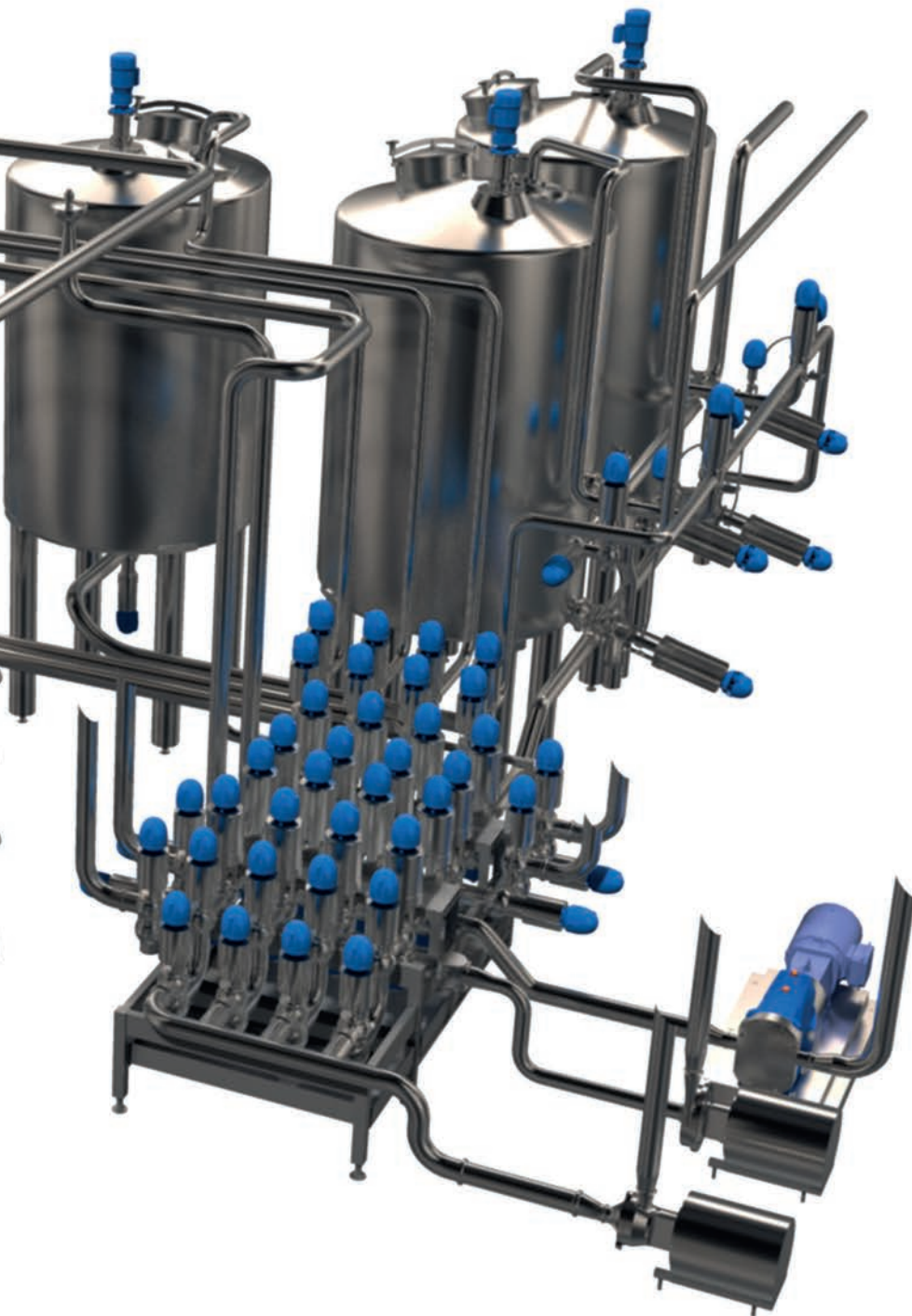

Performance in good hands

Working with hygienic applications is a question of care, attention to detail and dedication to outstanding performance. Alfa Laval has a proven track record in delivering innovative solutions for hygienic applications based on our core technologies of separation, heat transfer and fluid handling.

Superior safety, gentle efficiency and uncompromising cleanliness are the hallmarks of our hygienic valves and automation, pumps, heat exchangers, tubes and fittings, and separation, filtration and tank equipment. Which is why customers in the food, biopharm and other demanding industries put process performance and hygiene in the capable hands of our experts, sales companies and partners worldwide.

Here you will find an overview of Alfa Laval valves and automation for hygienic applications. For complete technical details and product specification, contact your local Alfa Laval supplier or visit us at **www.alfalaval.com**

Mixproof valves

Mixproof valves provide maximum flexibility and safety in hygienic flow processing by making it possible to handle two different fluids at the same time, with no risk of cross-contamination. Using two independent plugs and seals means a single mixproof valve can often replace two or more valves of other types.

Alfa Laval supplies several different designs of mixproof valves, all with leakage detection, that help boost reliability and safety levels. They enable you to design versatile set-ups that are both cost-effective and easy to maintain, as well as providing you with important new processing opportunities.

These include the Unique mixproof valve concept and the SMP range.

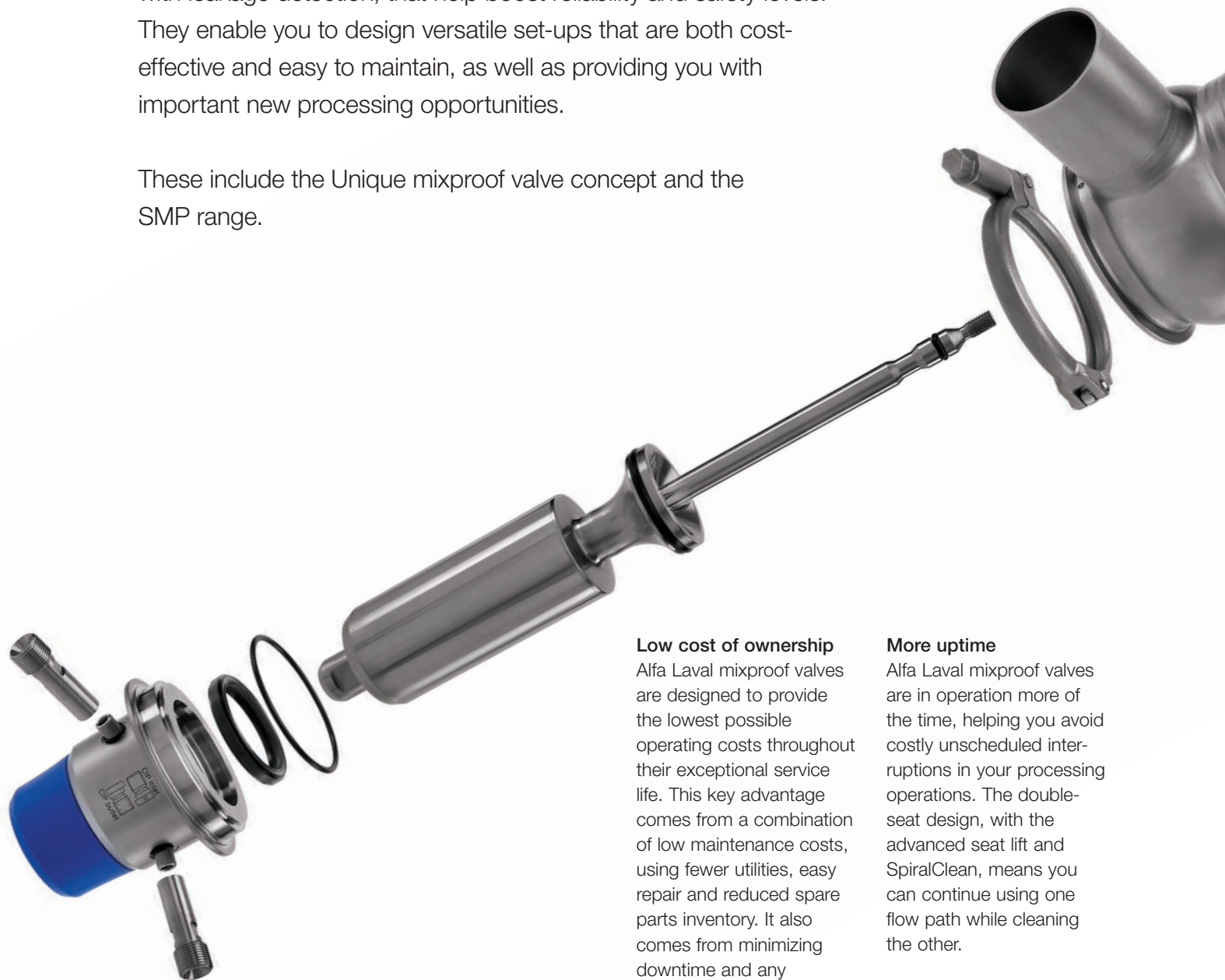

Low cost of ownership

Alfa Laval mixproof valves are designed to provide the lowest possible operating costs throughout their exceptional service life. This key advantage comes from a combination of low maintenance costs, using fewer utilities, easy repair and reduced spare parts inventory. It also comes from minimizing downtime and any resultant loss of earnings.

More uptime

Alfa Laval mixproof valves are in operation more of the time, helping you avoid costly unscheduled interruptions in your processing operations. The double-seat design, with the advanced seat lift and SpiralClean, means you can continue using one flow path while cleaning the other.

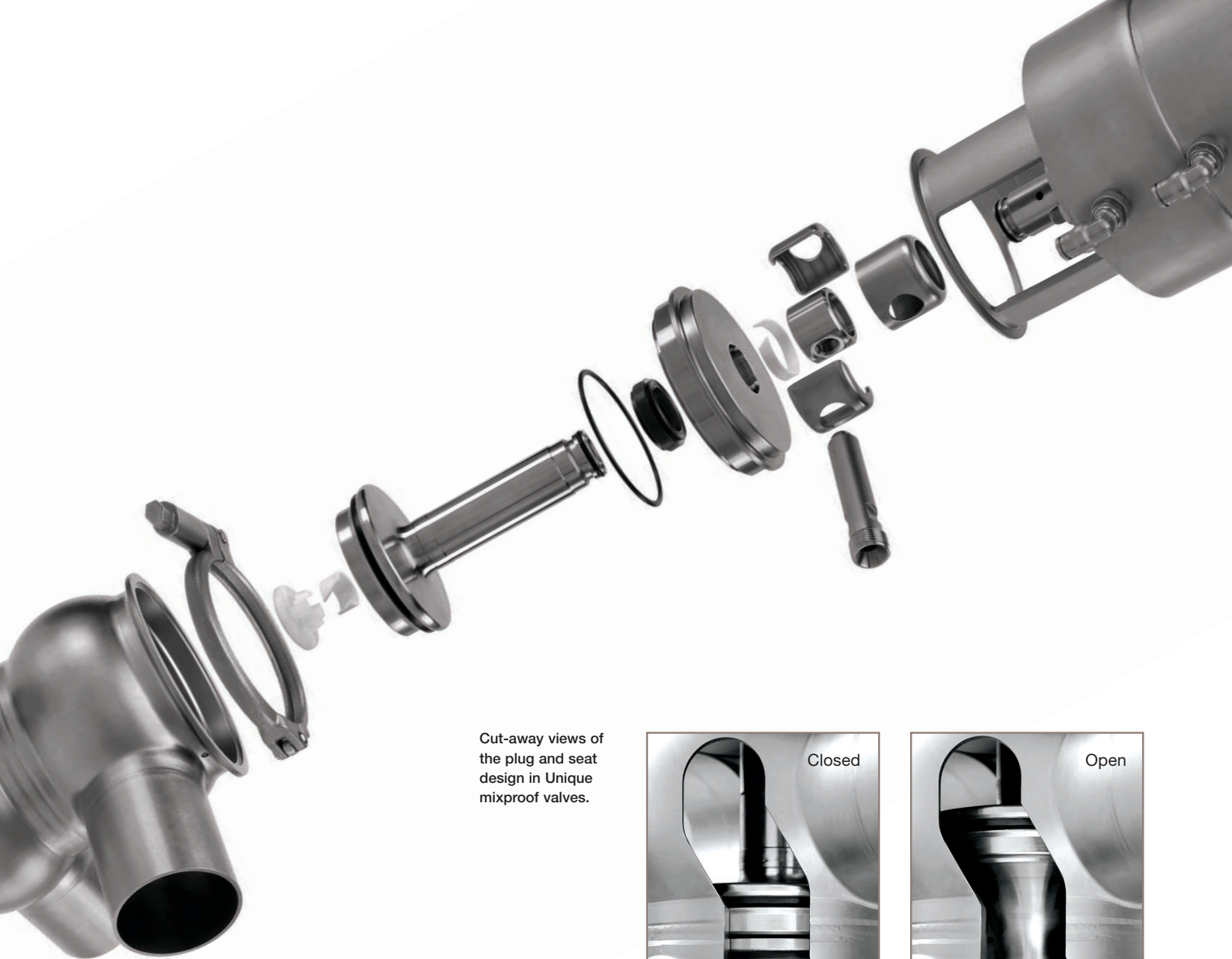

Cut-away views of the plug and seat design in Unique mixproof valves.



Greater flexibility

The modular concept behind Unique mixproof valves means you only pay for the exact features and capabilities you need. This gives you rapid payback and maximum return on investment. The concept also enables easy upgrades with additional features and functionalities, if your needs change. This ensures exceptional flexibility in designing your processing installation.

Reliable operation

The unique design of these mixproof valves, featuring a guided and protected radial seal, provides long-lasting operation. The double-acting lip seal also minimizes risk of product contamination. Alfa Laval mixproof valves can be fitted with monitoring systems for cost-effective process control.

Optimized maintenance

These valves are designed for quick, easy maintenance. Cost-saving advantages include the top-loaded, easy-to-dismantle design, no adjustable parts and a maintenance-free actuator that ensures safe repair, due to the caged spring.

Easy to clean

Alfa Laval mixproof valves feature built-in leak detection for maximum safety. Unique mixproof valves can be fitted with the proven SpiralClean system for the plugs and leakage chamber. This provides fast, more effective cleaning even under difficult conditions, using less cleaning fluid, utilities and time. A controlled seat lift ensures individual cleaning of the plug seals, with no risk of cleaning liquids mixing with the product.

Unique mixproof valves

The Alfa Laval Mixproof Valve concept is the ideal solution for any process application where high process safety and flexibility as well as the lowest total cost of ownership are required.

The Alfa Laval Unique Mixproof Valve concept provides modular solutions that you can easily tailor to your specific requirements. This also means you only pay for the exact features and capabilities you really need.



Alfa Laval Unique
UltraClean Mixproof Valve

UNIQUE MIXPROOF TANK OUTLET		UNIQUE MIXPROOF	
READING / CONFIGURATION DIRECTION ↓	CONNECTION		CONTROL
	VALVE BODY		
			ACTIVATION
	PLUG		
			CLEANING OPTION
	CLEANING OPTION		
			PLUG
	ACTIVATION	Non-balanced Balanced	
			VALVE BODY
	CONTROL		
			CLEANING OPTION
			↑ READING / CONFIGURATION DIRECTION

The selection guide illustrates the many combinations of features and equipment available with the Unique mixproof valve concept. In addition, there are different sizes and standards to comply with the full spectrum of worldwide installation standards. As a result, you can always find a configuration to meet any specific requirement. For configuration of your exact requirement, please use CAS or the electronic configurator in Alfa Laval Anytime, our eBusiness.

To assist you in the selection, these standard configurations are available. You can choose to use these directly or add additional features to ensure the valve suits your specific needs.



Alfa Laval Unique Basic has the basic components that provide significant safety and leakage detection. It features an actuator without seat lift and unbalanced plugs.



Alfa Laval Unique SeatClean is the choice for standard installations that handle products with solids. Seat lift during normal cleaning procedures cleans the plugs and seats. A balanced lower plug eliminates the risk of mixing products by pressure shock or when the pressure in the pipe is high.



Alfa Laval Unique HighClean meets your processing needs when dealing with sticky products. SpiralClean ensures thorough cleaning of the spindles, upper and lower plugs and in the leakage chamber. With balanced upper and lower plugs, the configuration of this valve protects against the effects of high pressure and water hammer.



Alfa Laval Unique UltraClean meets the highest demands for hygienic processing of sticky products, products with high content of solids, or applications that require close-to-aseptic conditions. It features an actuator with integrated seat lift, balanced upper and lower plugs and SpiralClean.



Alfa Laval Unique Tank Outlet is the choice for standard installations. Seat lift during normal cleaning procedures cleans the plugs and seats. A balanced plug protects against water hammer when closing in the direction of product flow.



Alfa Laval Unique Tank Outlet with external cleaning meets the highest hygienic demands for applications with sticky products, products with high content of solids or applications that require close-to-aseptic conditions. It features SpiralClean and plugs that lift independently to ensure thorough cleaning of the plugs, seats and corresponding pipe.

**Alfa Laval Unique Mixproof
Large Particle Valve**

For applications with very large particles or highly viscous fluids, the Alfa Laval Unique Mixproof Large Particle Valve (LP) offers the same basic advantages as Unique mixproof valves but are specially designed with large openings up to 45 mm in diameter.



SMP mixproof range

The Alfa Laval SMP Mixproof Valve is a cost-effective alternative to Unique mixproof valves yet still provides the advantages of mixproof design. The range is available in both on-off and changeover versions. The SMP mixproof valves are double-seat, self-draining units with no seat lift. They provide maximum safety with a minimum of moving parts, and are top-loaded to give easy access for dismantling and service.



Alfa Laval SMP-BC

Keeps liquids separate by using two seals on the same plug, with a leakage chamber in between. Often used as part of CIP (cleaning-in-place) set-ups, with leakage detection for greater safety. In such installations, seat lift is not necessary.

Alfa Laval SMP-BCA

As SMP-BC, but fitted with a PTFE/rubber diaphragm, designed for use under aseptic conditions, and sterilization involving high temperatures.

Unique mixproof tank outlet valves

Same basic advantages as the unique mixproof valves but specially designed for vertical and horizontal mounting directly on the tank wall at the inlets and outlets.

Alfa Laval Unique Mixproof Tank Outlet Valve

For tank inlet and outlet applications, the Unique mixproof tank outlet (TO) valve offers full drainability and provides cleanability all the way up to the tank without any risk of cross-contamination.



Alfa Laval Unique Mixproof Horizontal Tank valve

Offers the same basic advantages as unique mixproof valves but is specially designed for horizontal mounting directly on the tank wall. It improves cleanliness of the horizontal tank connections and ensures that no area of the tank inlet or tank outlet is left uncleaned.



Single seat valves

Single seat valves feature one single contact surface between the plug and the seat. They are one of the fundamental building blocks in virtually every kind of process installation. This means they have to be supremely reliable and versatile in order to maintain uninterrupted production with a high hygiene standard.

The Alfa Laval range of single seat valves bears the designations Alfa Laval Unique SSV and Alfa Laval Unique SSSV, and consists of large numbers of purpose-designed valve units that are particularly robust and flexible.



The most for your money

You benefit from a relatively simple, straightforward design with a minimum of components and few moving parts, reducing service requirements and keeping inventory costs down. You get the best possible return on investment as a result of enhanced service life and exceptional reliability, combined with reduced product loss, greater product safety and improved hygiene.

Lower engineering costs

Alfa Laval Unique SSV valves provide full traceability in compliance with the EU Food Regulation 1935/2004. They also have EHEDG certification and can be delivered with 3-A labelling. The modularity of the design, with the many combination possibilities this provides, significantly reduces the engineering costs of setting up processing plants around the world.



Exceptional hygiene

The valve body is made from a single disc of stainless steel with a $Ra < 0.8 \mu m$ final internal surface finish. The weld-free, ball-shaped body eliminates bacterial traps, and the design of the plug and seal support more effective cleaning and exceptional hygiene. The double-acting lip seal minimizes any risk of product contamination by air or dirt.

Low cost of ownership

The design of these valves makes them easy to clean and keep clean, with a minimum of maintainable parts. This saves you time, resources, manpower and inventory. The costs of ownership are reduced still further by exceptional durability, reduced product loss and more processing uptime. The actuator design also provides more accurate valve performance.

Greater durability

The unique design used in Alfa Laval Unique SSV valves, featuring defined compression of the O-rings and metal-to-metal contact between plug and seat, not only provides better sealing but also extends the service life of Alfa Laval Unique SSV valves.

Saving on resources

The reliability of Alfa Laval Unique SSV valves means you have less product wastage to deal with. And because they are designed with effective CIP (cleaning-in-place) procedures in mind, you use fewer expensive cleaning fluids, less water and fewer utilities in general, resulting in a reduced environmental impact.

Unique SSV single seat valves

The modular basic design of Alfa Laval Unique SSV single seat valves centres round a body deep-drawn from one single stainless steel disc, an efficient double-acting lip seal design that minimizes any risk of cross-contamination, and a valve plug with enhanced CIP (cleaning-in-place) capabilities.

You can also combine different configurations with different types of actuator. This cost-effective modular design approach gives you the opportunity to build either shut-off or changeover valves, in either normally open/normally closed or reverse-acting configurations, to meet virtually any requirement.



The selection guide illustrates the many combinations of features and types available with the Unique SSV valve range. In addition, there are different sizes and standards to comply with the full spectrum of worldwide installation standards. As a result, you can always find a configuration to meet any specific requirement. For configuration of your exact requirement, please use CAS.

Alfa Laval Unique SSV Valve (standard configuration)

As the world's most widely used single seat valves, the Alfa Laval shut-off and changeover configurations are employed for a broad spectrum of different processing duties.



Alfa Laval Unique SSV Aseptic Valve

A one-piece diaphragm provides hermetic sealing against intrusion from the atmosphere, ensuring full protection against the effects of micro-organisms during processing.

The special diaphragm can also be used with other Alfa Laval Unique SSV units – including standard, tangential, two-step and tank outlet valve configurations – where aseptic processing is crucial.

Alfa Laval Unique SSV Y-body Valve

Normally used in installations that involve flows featuring large particles and/or high viscosity, and where the focus is on particularly gentle treatment of products and flows.



Alfa Laval Unique SSV Tank Outlet Valve

Consists of a valve body with or without a tank flange. Available in two different versions for installations that either open into the tank (reverse-acting) or close up against the tank (standard version).



Alfa Laval Unique SSV Long-Stroke Valve

Specially suitable for use with media or products that contain particles and/or suspended solids, and also with high-viscosity flows. In such cases, larger openings are needed to provide gentler, more effective flow control.

Alfa Laval Unique SSV Tangential Valve

Features an off-centre body so that the port connection can still be drained when the valve is positioned horizontally.

Particularly suitable for use in tank openings, horizontally mounted drains and a wide range of installations where space restrictions make it difficult to install valves at other angles.



Alfa Laval Unique SSV Two-step Valve

Lifting height can be adjusted as required to match specific volumes and quantities. This makes it especially suitable for dosing, and for two-stage filling where the focus is on ensuring an exact volume. Can also be used for draining two pipes at the same time.



Alfa Laval Unique SSV Reverse-acting Valve

Provides multiple solutions, for instance, to prevent pressure shocks when the pipe work does not permit closing against product flow with the use of standard single seat valves. May be used as an overflow valve after a positive displacement pump or as a multi-port flow diversion valve. Can also be configured as a shut-off valve with two or four ports, or as a changeover valve with three to six ports.



Alfa Laval Unique SSSV Small Single Seat Valve

Features a particularly simple design and few moving parts.

Widely used in processing food, beverages and dairy products, as well as pharmaceuticals and personal care products. Ideal for use in sampling, CIP (cleaning-in-place) and other contexts where only small flow rates are involved.



Alfa Laval Unique SSV Manually Operated Valve

Small, relatively simple valves that are available with many different options and features, including lockable flights, for either regulating or dosing purposes.

Butterfly valves

Alfa Laval LKB butterfly valves are relatively straightforward on/off routing valves with a substantial opening area and low flow resistance. This makes them the workhorse solution in modern processing technology, ideal for use with low and medium-viscosity liquids. In addition the patented Alfa Laval Clamp Butterfly Valve is optimized for easy maintenance making it possible to retract the seal while the valve is still placed in the pipeline.



Seal technology

The unparalleled technical resources of Alfa Laval enable us to provide you with a comprehensive range of elastomer seals to meet all requirements. Different materials and specifications can provide greater thermal stability, better chemical resistance and improved tensile strength – adding up to longer, more reliable service.

Disc benefits

Alfa Laval butterfly valves feature a highly polished stainless steel disc with surface smoothness down to $Ra < 0.8 \mu m$. The disc design has been thoroughly tested. The bearing bushes are clipped onto the disc stems, avoiding any metal-to-metal abrasion and ensuring smoother disc movement.



Strength under pressure

Different models are available for working at pressures from full vacuum up to 10 bar. This is one reason why Alfa Laval LKB butterfly valves feature a 12 mm stem diameter – larger and more solid than the industry norm. This additional strength helps withstand pressure shocks better, resulting in better operating safety and greater reliability.

Wide-spectrum compatibility

These valves are manufactured for full compatibility with both metric and imperial tubing and virtually all dimension standards, including ISO, DIN, JIS, ASME, etc. Compatibility with multiple standards also provides significant logistics advantages as well as opportunities for participation in advantageous Alfa Laval purchasing plans.

Exceptional hygiene

These highly reliable valves conform with FDA requirements. Alfa Laval inspection certificates and 3.1 traceability certification are also available, on request. The benefits of Alfa Laval seal technology also play a major role in preventing any kind of contamination.

Matrix advantage

Alfa Laval LKB butterfly valves can easily be mounted in even complex matrix set-ups, side-by-side with valves of other types. Using Alfa Laval control and monitoring technologies, they can also be integrated into a broad spectrum of electronic control systems, for maximum efficiency.

LKB butterfly valves

The Alfa Laval LKB range of butterfly valves consists of modular units designed to meet the full spectrum of requirements for effective, reliable butterfly valves at working pressures from full vacuum to 10 bar.



The selection guide illustrates the many combinations of features and equipment available with LKB butterfly valves. In addition, there are different versions to comply with the full spectrum of worldwide installation standards. As a result, you can always find a configuration to meet any specific requirement.

Alfa Laval LKB with standard handle

Available with standard handle for straightforward manual operation, with a pulling/turning movement. The standard handle has a spring-locking action.



Alfa Laval LKB-F for flange connections

Special version that makes it easy to remove the valve body without needing to dismantle piping set-ups. This in turn makes it easy to undertake repair, service and replacement with a bare minimum of disruption.

Alfa Laval LKB with actuator

A selection of different actuators is available. The special actuator design, featuring double springs, makes sure that maximum torque is applied to the valve disc at breakaway and seal positions. This results in efficient, reliable opening and closing. Alfa Laval actuators are renowned for their exceptional reliability, regardless of operating conditions.



Alfa Laval Clamp Butterfly Valve

The practical design of this in-line valve helps reduce the total installation cost. With a handle that can be mounted step-less (360°) in any direction, it is a very flexible solution and, thanks to its easy assembly and disassembly, the valve is ideal for applications that require fast and frequent maintenance.

Unique Control

With its integrated automation, Unique Control consistently ensures an optimal interface between the actuator and the automaton.

Reliable simplicity

Unique Control is an innovative actuator that is controlled by an air spring instead of a conventional mechanical spring. Combined with the intelligent capabilities of the sensing and control unit, it delivers significant benefits both in terms of durability and reliability, thereby ensuring more system uptime. Tested to over a million strokes without service, it is the most durable actuator available today. The hygienically designed casing withstands harsh environments without weakening, corroding or discolouring.

One size fits all

The Alfa Laval Unique Control LKB fits all valve sizes from 1" to 4" (DN 50 to DN 100). With the option to switch from normally open (NO) to normally closed (NC) onsite, a single actuator covers the majority of all possible valve solutions. Existing installations are easy to upgrade to Unique Control; all that is required is a new bracket. Existing actuators may gradually be upgraded as they become due for renewal and enhanced with valve sensing and control for intelligent automation.

Intelligent performance

By simply pressing one button, Alfa Laval Unique Control LKB detects the valve positions and monitors the air pressure in the system to support self-configuration to the best possible mode of operation. It is not sensitive to pressure shocks or temperature variations, thereby eliminating false alarms that can shut down the process. The all-in-one design also makes it more hygienic.



Alfa Laval Unique Control LKB provides a 360-degree view of the valve operation mode.



Ball valves

Ball valves are constructed around a full-bore design. This makes sure the product passes through the valve with no restrictions on the flow, and that there is only minimal pressure drop. This basic design allows cleaning and product recovery using pigging systems, and also makes this kind of valve ideal for use with viscous liquids and liquids containing solid or semi-solid particles. Alfa Laval ball valves for hygienic use bear the SBV and Tri-Clover® designations.

Alfa Laval SBV Sanitary Ball Valve

Alfa Laval SBV units are designed for use as a product valve, and are available with pneumatic actuators or manually-operated handles. Ideal for applications that involve high operating pressure and temperatures as well as where the use of pigging systems is required.



Alfa Laval Tri-Clover Ball Valve

Ideal for applications that require a full-flow body design to minimize line turbulence and pressure drop. An encapsulated seat option is available for applications where it is important to reduce potential product entrapment as much as possible.

Regulating valves

Regulating valves are the right choice when flow volumes and flow directions must be adjusted or monitored. Specially designed for use in a broad range of metering, blending, weighing and filling system applications, they are the ideal solutions for precision control of flow rate or pressure.



Alfa Laval CPM-2 Valve

Designed to maintain a constant pressure at the valve inlet or outlet, using different plug sizes and different Kv values. These react effectively to any changes in product pressure by shifting position against a constant air pressure. Often used upstream of filling and bottling machines, etc.

Alfa Laval LKC-2 Non-return Valve

Non-return valve that opens when the pressure below the valve plug exceeds the combination of the pressure above the plug and the spring compression force. The valve closes when pressure equalization is reached. Any higher pressure above the valve plug forces it to close against the seat, preventing any reverse flow.



Alfa Laval SPC-2 Valve

Electro-pneumatic modulating valve that features an IP converter as an integrated part of the actuator. Available with a range of plug designs with different Kv values, providing different capacities. This type is widely used for the accurate control of pressure, flow, temperature and the level of liquids in tanks.

Alfa Laval Unique RV-ST Regulating Valve

Push-and-play regulating valve with integrated IP converter built on the Unique SSV platform. Offers plug designs with different Kv values, which provide different capacities. This enables effective control of product flow by combining different pressure drops and stroke lengths. Widely used as a regulating valve in metering, blending, weighing and filling duties.



Special valves

Alfa Laval provides a comprehensive selection of valves that are designed for particular purposes and to meet special requirements.

Alfa Laval LKAP Air-operated Valve

A straightforward, remotely controlled, air-operated shut-off valve widely used for small flows, and for dosing applications in the food and chemical industries.



Alfa Laval Unique Sampling Valve

Special valves designed to help ensure effective sterilization before and after taking each sample. Different versions are available for high-viscosity and low-viscosity products, and for taking samples using a hypodermic needle.



Alfa Laval LKUV-2 Air-relief Valve

Double-seat automatic air-relief valve with a freely moving ball that closes against the upper or lower seat, depending on pressure conditions. Designed for use when it is important to remove any air present. Examples include vertical mounting on top of a pipe run or container, or upstream from a pump inlet.



Alfa Laval LKBV Air-blow Valve

Solenoid-operated valve for emptying liquids from pipe runs or for agitating the contents of tanks by blowing in air.

Alfa Laval MH Shutter Valve

Self-draining valves that can allow product to flow in different directions. An internal shutter closes the valve ports progressively to help minimize pressure shock and stress on both the valve and the liquids passing through. Available in manually and single or double-acting pneumatically operated versions, and normally used in systems where it is important to contend with pressure shocks.



UltraPure valves

Tailored for the challenges of the biopharm industry and other demanding hygienic applications, the Alfa Laval UltraPure valve range is designed to meet cGMP (current Good Manufacturing Practices). It is supported by the Alfa Laval Q-doc documentation package, which facilitates the validation process.

Well-documented performance

Alfa Laval Q-doc is a state-of-the-art documentation package for all UltraPure products and is based on GDP (Good Documentation Practices). Q-doc documents every aspect of manufacturing from raw material to delivered equipment. With full transparency of sourcing, production and supply chains, it is easy to trace the slightest change in material or manufacturing procedures, even when it comes to spare parts. All product contact parts, such as steel and gaskets, are fully traceable to ensure correct design performance and validation right from the start.

Q-doc comprises equipment manuals, quality and manufacturing procedures, relevant material certificates and necessary parts and service information for standard components.

Reliable, high performance products ensure in-batch and batch-to-batch consistency, safeguarding product characteristics and quality.

Learn more at www.alfalaval.com/biopharm



Alfa Laval Ball Valve UltraPure



Alfa Laval LKB UltraPure



Alfa Laval LKC UltraPure



Alfa Laval Unique DV-ST UltraPure



Alfa Laval Unique Diaphragm Valve-Premium UltraPure



Alfa Laval Radial Diaphragm Valve UltraPure

Aseptic diaphragm valves

Aseptic diaphragm valves are most commonly used in the pharmaceutical industry. However, they are also ideal for use in other processing installations where it is crucial to prevent any increase in micro-organism concentrations.



Alfa Laval Unique Diaphragm Valve-Premium UltraPure

The Alfa Laval Unique Diaphragm-Valve Premium UltraPure gives double flow rate compared to conventional designs, with significantly reduced pressure drop. It also has a more linear flow characteristic, which results in a more precise flow regulation.

Alfa laval Unique DV-ST UltraPure Diaphragm Valve

Features a light, compact actuator with easy conversion of control function (NC-Air/Air/NO). Has an extensive range of well-proven diaphragms and high quality valve bodies with low delta ferrite and specified sulphur content.



UNIQUE DIAPHRAGM									
								CONTROL	
								ACTIVATION	
								DIAPHRAGMS	
								VALVE BODY	

Stainless steel

Composite/
Stainless steel

Composite

Stainless steel

Composite/
Stainless steel

Composite

Composite

Composite

Composite

Threaded

Button

Bayonet

Threaded

2-way valve

T-valve

T-block valve

Multiport valve

Tandem valve

Block tank
outlet valve

2-way valve

The selection guide illustrates the many combinations of features and equipment available with the aseptic diaphragm valve concept. In addition, there are different sizes and standards to comply with the full spectrum of worldwide installation standards. As a result, you can always find a configuration to meet any specific requirement.

Valve control and monitoring

One of the most effective ways to reap full benefit from high-quality hygienic valves is to control and monitor their action as accurately, reliably and economically as possible. Alfa Laval provides a full range of easy-to-install, easy-to-use valve-top control and monitoring indicator units for use with hygienic valves.

More reliable, cost-effective control

Traditional indicators are rarely capable of maintaining pre-set parameters for valve operation. Alfa Laval units solve this by using a state-of-the-art, no-touch sensor system, pre-configured with a tolerance band. This does away with adjustments during the unit's service life, providing you with a time-saving, set-and-forget solution that also keeps production downtime to a minimum.

Cost-effective combinations of our ThinkTop® top-mounted automated control head for pneumatic valves and IndiTop valve position indicators give you full control over fluid handling processes – with the exact degree of automation you require.

Alfa Laval valve-top control and indicator units benefit your operations by ensuring:

- Better control and monitoring of processing operations
- Full insight and documentation about actual events
- Greater safety and reliability
- Low cost of ownership due to savings on time and manpower and elimination of downtime and errors
- Easy upgrading, expansion and reconfiguration of existing installations, with no adaptors required.

Easy to install

These units fit onto all Alfa Laval hygienic valves fitted with actuator valve-tops in an easy, straightforward procedure that requires no special expertise or costly adaptors. This makes them ideal for retrofitting and updating your existing processing plant and for increasing flexibility. Once fitted, the initial set-up is done manually using a fast and foolproof “five-push setup”.





Alfa Laval
Unique Control
LKB



Alfa Laval LKB
Butterfly Valve
with Alfa Laval
ThinkTop D30



Alfa Laval
Unique SSV
Single Seat Valve
with Alfa Laval
ThinkTop Basic



Alfa Laval Unique
Mixproof Valve
with Alfa Laval
ThinkTop

Built to last

Alfa Laval control and indicator units are built for maximum durability, providing long-term service both indoors and outdoors. They comply with the stringent IP66 and IP67 standards for protecting electronic equipment against penetration by dust particles or liquids.

ThinkTop automated control heads for pneumatic valves are completely watertight and suitable for use in any known operating environment. They are also fitted with GORE™ protective venting technology that gets rid of any accumulated moisture.

All the materials used help protect against the effects of physical impact, UV radiation and working environments in which grease, oil and chemicals may be present.

Data about the settings for each valve is automatically stored in the unit's own memory. This important information is therefore fully protected against the effects of any power failure.

Safe and rugged

Alfa Laval control and indicator units have well-proven features designed to ensure maximum safety during production by making sure that each valve is doing exactly what it is supposed to – regardless of conditions.

The “no touch” sensor system is less sensitive to the effects of temperature and vibration because they are moulded directly into the valve-top units.

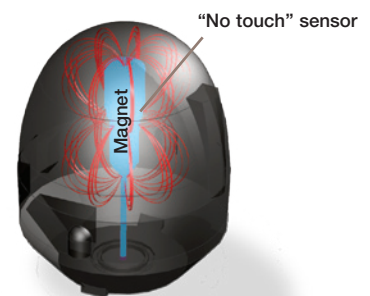

The sensor detects valve stem movement with extremely high accuracy. This means these units can be set up with individual tolerance bands for detecting any deviation in the opening/closing of the valve plug. This helps prevent any operating errors that may result in wasted production.

Low cost of ownership

Alfa Laval control and indicator units give you a remarkably low cost of ownership via savings on time, manpower and installation costs, as well as by boosting production uptime throughout the service life of the unit.

Alfa Laval ThinkTop and Alfa Laval IndiTop units feature modular, fully encapsulated (potted) designs that are extremely robust and have only a small number of components. This saves on spare parts inventory and maintenance costs throughout their service life.

Alfa Laval ThinkTop

This premium top-mounted automated control head for pneumatic valves gives you access to the full range of electronic interfaces available for operating solenoid valves, transmitting feedback signals and ensuring the operator full benefit of Alfa Laval hygienic valves.

ThinkTop units make it possible to fulfil all the requirements for automated valve monitoring and control - minimizing waste and maximizing the traceability during production.



Alfa Laval ThinkTop Basic. Inherently safe for ATEX environments

Alfa Laval ThinkTop Basic

This standard top-mounted automated control head for pneumatic valves fulfils requirements for the automated sensing and control of hygienic valves, with a reduced number of digital inputs and outputs.

Installing the Alfa Laval ThinkTop Basic units is both quick and easy, and helps provide a cost-effective degree of flexibility in controlling an automated production.

Alfa Laval ThinkTop D30

This basic top-mounted automated control head for pneumatic valves provides basic automated sensing and control of hygienic valves, designed with inputs and outputs, and as an alternative solution to external solenoid valve and for use on non-critical valve actuators.

The plug 'n' play setup makes it quick and easy to install, which eliminates fault handling during commissioning and production. It is designed and meet the market challenges for even more usability and hassle-free control of automated valves.



Alfa Laval ThinkTop D30



Alfa Laval IndiTop

The Alfa Laval IndiTop top-mounted indicator units are designed to transmit feedback about the current position of any hygienic valve. No solenoids are used, eliminating the need for feedback adjustment over time and, making this a true set-and-forget system.



Side indicator brackets

Certain Alfa Laval valve types are available with special side indicators and brackets for mounting a range of different sensors.

Getting the message across

Alfa Laval control and indicator units are designed to provide you and your staff with accurate, reliable information about the exact operating status of your hygienic-standard valves at any given time.

This important information is always presented visually, with colour-coded LEDs to make sure operators can see the current valve position and whether the power is on or off.

Broad interface compatibility

Alfa Laval control and indicator units can also provide digital electronic feedback by relaying sensor data about the exact valve position to a programmable logic controller (PLC) via a range of different industry-standard configurations. These include traditional digital interfaces, the relatively simple AS-Interface system and the more advanced DeviceNet™ fieldbus interface.

By combining bus systems and digital technologies, Alfa Laval equipment is compatible with all major PLC digital input/output cards and gateways for communication via other fieldbus systems. This makes it easy to combine different types of control and indication units and data communication interfaces to meet your particular valve control needs at any given time.

Flexibility for changing requirements

Alfa Laval valve automation technology enables you to combine different valves, different control equipment and different communication protocols as you see fit, to deal with your changing requirements.

Alfa Laval solutions also let you streamline interface and wiring configurations by connecting feedback signals from multiple control or indicator units into one. This greatly reduces the investment required to implement efficient, future-compatible valve control and monitoring set-ups.



Digital interface

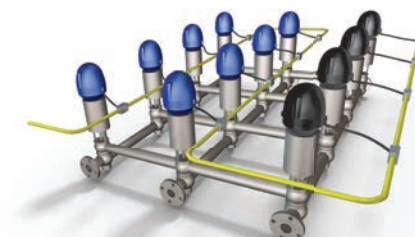

AS-Interface

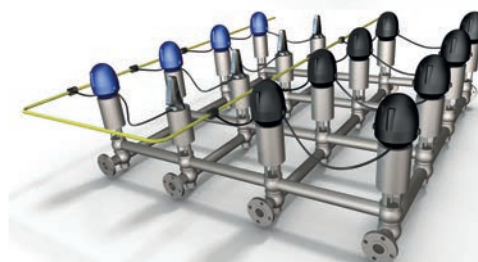

Combination of different communication protocols

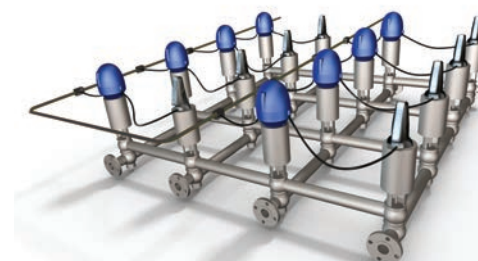

DeviceNet

Flow management solutions

Alfa Laval supplies a vast selection of different types of hygienic valves, in many different configurations and sizes. This is backed by the know-how and experience essential for configuring any installation in the most cost-effective way, no matter how complex.

Full spectrum

Alfa Laval can provide you with a comprehensive range of hygienic valve equipment, designed to meet virtually all your requirements.

- DN4–150 (3/8 to 6 inches) in size.
- Virtually all dimension standards, including ISO, DIN, ASME, etc.
- 1.4435 (316L) and 1.4404 (316L) standards for stainless steel.
- Seals made of EPDM, PTFE, HNBR, FPM, Q silicone and PFA.
- Surface finishes with roughness values of Ra 6.3–0.25 µm, including electro-polished options.
- Internationally recognized hygiene ratings, including options for aseptic operation.
- Compliance with a wide range of key international standards, including FDA approval, 3-A conformity certificate, EHEDG compliance, ATEX, etc.



Full details about all Alfa Laval hygienic valves are available in the “Close at hand” catalogue at www.alfalaval.com/high

Overview of Alfa Laval hygienic valves								
Valve categories	Duty							
	On-off valves	Regulating valves	Sampling valves	Tank outlet valves	Divert valves	ATEX valves	P/M*	Aseptic valves
Unique mixproof	●			●		(●)***	P	
SMP	●				●	●	P	●
Unique SSV	●			●	●	●	P/M	●
Unique SSSV	●				●		P/M	
CPM-2		●				●	P	●
LKC-2		●				●	P	
SPC-2 & RV-ST		●					P	●
Unique sampling valve			●				P/M	
MH shutter valve	●					●	P/M	
LKB & Clamp butterfly valve	●			●		●	P/M	
Ball valve	●					●	P/M	
Unique diaphragm valve	●	●		●	●	●	P/M	●
Radial diaphragm valve	●			●			P/M	●

Everything you need

Alfa Laval combines the offering and advantages of a global brand with the individual attention of local sales and channel partners, creating a one-stop shop with the world's largest accumulation of process expertise. In addition, we provide effective, time-saving software tools that help you easily configure, size and receive supporting dimensional drawings for hygienic valve installations.

Computer-Aided Selection software (CAS)

Alfa Laval's CAS software helps you quickly and easily identify the valve configuration best suited for your particular process. It also provides you with a clear visual overview while you are configuring each valve. CAS includes drawings, article numbers and spare parts lists, quickly and easily compiling ordering lists and streamlining your maintenance and service procedures.

Computer-Aided Design (CAD)

Our CAD portal offers dimensional drawings of all Alfa Laval mixproof valves, single seat valves and butterfly valves. Any user can download 2D and 3D CAD drawings in both neutral and native formats.

Extending equipment performance by 360° service

Through Alfa Laval's broad range of spare parts, equipment, and services you get the support you need when you need it, performed by skilled and knowledgeable staff.

With Alfa Laval service you maximize the reliability and uptime of your equipment. The result is superior performance throughout the equipment life cycle – performance that puts you ahead of competition.



For more information visit www.alfalaval.com/high

		Control and monitoring								
UltraPure	Piggable	Unique Control	ThinkTop	ThinkTop Basic intrinsically safe	ThinkTop Basic	ThinkTop D30	IndiTop	Side indicator	Bracket system	Other
	●		●	●	●		(●)**	●	●	
	●		●	●	●		●	●	●	
	●		●	●	●	●	●		●	
			●		●	●	●			
●										●
										●
			●	●	●		●	●	●	
●	●	●	●	●	●	●	●	●	●	●
●										●
●										●

* Pneumatic and/or manually operated.
 ** Can be fitted and used on this type of valves, although this is not standard practice.
 *** In order to use Unique mixproof in ATEX environment, the blue plastic cover must be removed.

Alfa Laval in brief

Alfa Laval is a leading global provider of specialized products and engineered solutions.

Our equipment, systems and services are dedicated to helping customers to optimize the performance of their processes. Time and time again.

We help our customers to heat, cool, separate and transport products such as oil, water, chemicals, beverages, foodstuff, starch and pharmaceuticals.

Our worldwide organization works closely with customers in almost 100 countries to help them stay ahead.

How to contact Alfa Laval

Up-to-date Alfa Laval contact details for all countries are always available on our website at www.alfalaval.com

Tri-Clover is a trademark registered and owned by Alfa Laval Corporate AB, Sweden.
ThinkTop is a trademark registered and owned by Alfa Laval Corporate AB, Sweden.
Alfa Laval is a trademark registered and owned by Alfa Laval Corporate AB, Sweden. © 2011 Alfa Laval.

